

ALKON[®]

MATERIAL HANDLING - ESD - OFFICE PRODUCTS

Shreeram metafusion Eng's Pvt. Ltd.

Increasing productivity & Optimizing Space



OFFICE PRODUCTS

AUTHORISED STOCKIST

Shreeram
metafusion
Eng's Pvt. Ltd.

AUTHORISED STOCKIST

Shreeram
metafusion
Eng's Pvt. Ltd.

Shop - 1, Gagangiri, Sector 17,
Vashi, Navi Mumbai - 400 703.
Tel.: 2789 1522 / 2789 1549
6791 0552

Email : metafusion@vsnl.net
enquiry@shreeram-metafusion.com

For Product Details log on to www.shreeram-metafusion.com

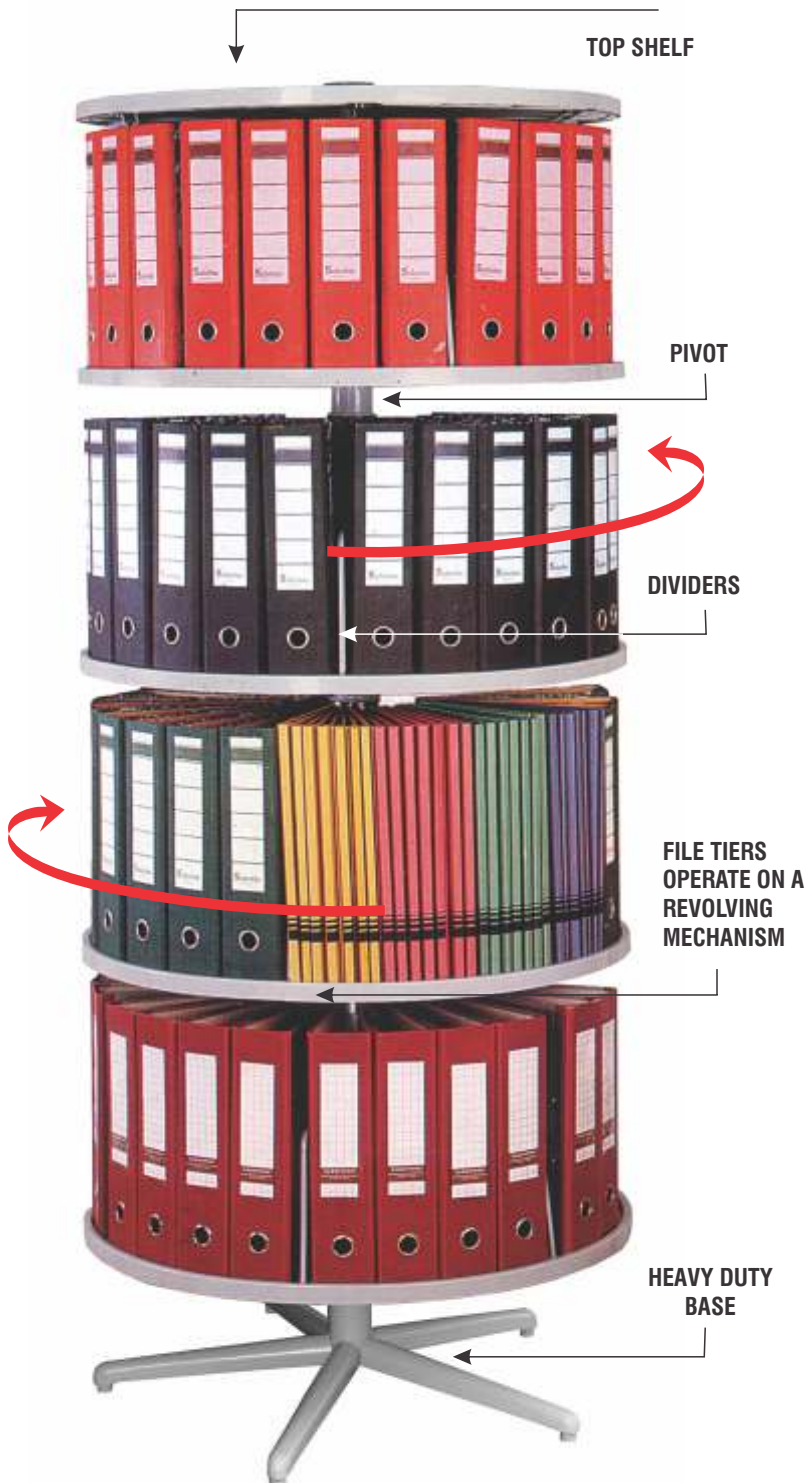
ALKON**ROUNDFILE****ROUNDFILE - EASY, SIMPLE, EFFICIENT****THE PERFECT SOLUTION FOR STORING AND RETRIEVING OFFICE FILES & FOLDERS.****SPACE SAVING :**

Roundfile systems saves upto 60% of the space needed for other filing systems. Roundfile provides maximum ease of retrieval in minimum space. Roundfile system saves expensive office wall space.

**ECONOMICAL :**

Roundfile system is the most economical filing system available. Price comparison shows that Roundfile system saves upto 50% in cost as compared to conventional wall filing systems. Why pay more when planning offices? Check and compare !

**TIME SAVING :**

With Roundfile system you retrieve your files at the greatest possible speed. Each tier revolves independently to display 24 Box files or 80 to 100 flat files at a glance.

A FILING SYSTEM THAT GROWS AS YOUR NEEDS GROW !**UNIQUE WAY TO ARRANGE YOUR OFFICE FILES AT ONE PLACE.****Shreeram** metafusion Eng's Pvt. Ltd.www.shreeram-metafusion.com

HAS A MODEL TO SUIT YOU JUST SPIN AND CHOOSE

- ▶ Made from ABS Plastic
- ▶ 78 cms. Dia with 6 Partitions
- ▶ 24 Box Files or 80 to 100 Flat Files per tier.



COLOURS

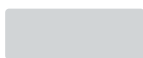

Light Grey



Beige



Brown

Please note: Colors shown here are similar, not exact, to actual product colors.

GROW !

NEEDS

YOUR

AS



2 TIER

48 BOX FILES OR
200 FLAT FILES
DIAMETER : 78 CM
TOTAL HEIGHT : 108 CM



3 TIER

72 BOX FILES OR
300 FLAT FILES
DIAMETER : 78 CM
TOTAL HEIGHT : 149 CM



4 TIER

96 BOX FILES OR
400 FLAT FILES
DIAMETER : 78 CM
TOTAL HEIGHT : 189 CM



5 TIER

120 BOX FILES OR
500 FLAT FILES
DIAMETER : 78 CM
TOTAL HEIGHT : 230 CM



A product designed and manufactured with meticulous care by **ALKON**. Standard cabinet with four sizes of interchangeable drawers. Store Files, Documents, Papers, Office Stationery etc.

All cabinets are provided with Central Locking System. Cabinets can be interlocked side by side or one on top of each other.

CABINETS AND DRAWERS - LIGHT GREY COLOUR

Please note: colors shown here are similar, not exact, to actual product colors.





Internal size of Drawers
 D1 - 360mm x 265mm x 16mm
 D2 - 360mm x 265mm x 39mm

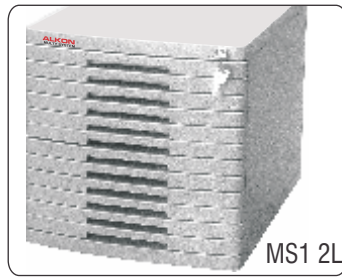

With 12 D1 Drawers and Lock



With 6 D2 Drawers and Lock



Size of Cabinet
 D - 410mm x B310mm x H 333mm
 CHL only cabinet with lock



Internal size of Drawers
 D3 - 360mm x 265mm x 62mm
 D4 - 360mm x 265mm x 87mm



With 4 D3 Drawers and Lock



With 3 D4 Drawers and Lock



Central Lock



Mix Drawers
 3 Nos. D1 Drawers 1 No. D3 Drawer
 1 No. D2 Drawers 1 No. D4 Drawer



Push up the indicator to remove & change the name.



Lift the Drawer up and remove from Cabinet.

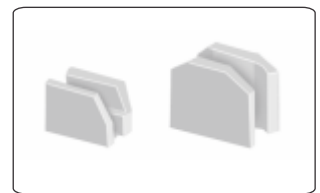

Set of clips for interlocking of cabinets.

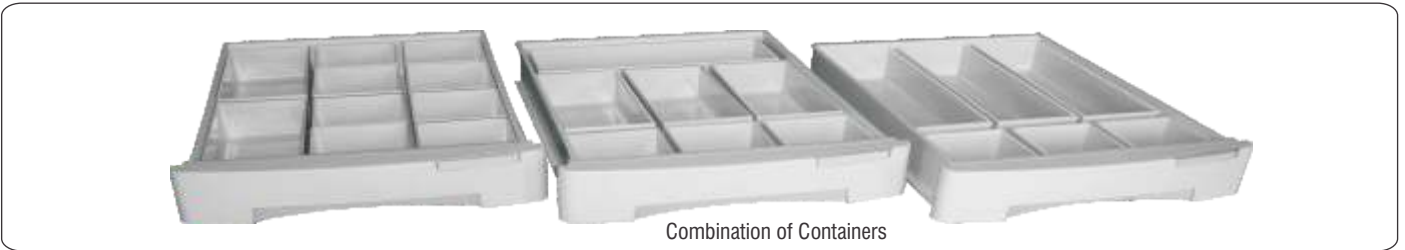

Combination of Containers

UTILITY CONTAINERS

For storing of small parts, Three sizes of containers are available to fit in D3 / D4 drawers in C. Grey Colour.

Sizes of Containers :

Art No. UC1 (C. GREY) Size 82 x 82 x 55mm

12 Containers fit in one D3 / D4 drawer

Art No. UC2 (C. GREY) Size 170 x 82 x 55mm

6 Containers fit in one D3 / D4 drawer.

Art No. UC3 (C. GREY) Size 255 x 82 x 55mm

4 Containers fit in one D3 / D4 drawer.



Laminated Tops

Mobile base units

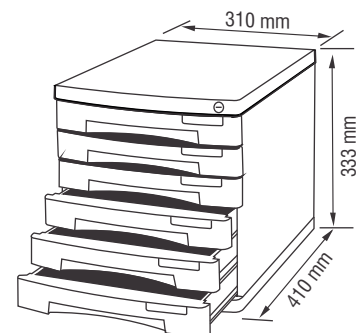

Modular System - Beige / Grey / Blue

is an ideal plastic filing system based on standard modules which can be interlocked and stacked on top of each other.

The basic system is around four drawer sizes which can be interchanged in the ratio of 1 : 2 : 3 : 4. all cabinets can be supplied with / without central locking system.

Applications

Due to the system being modular in nature, these systems are used in a large variety of applications like Offices, Hospitals, Homes, Electronics, Engineering and Textile Industries.

MODULAR SYSTEMS -BEIGE



CABINET & DRAWERS DRAWER FRONT

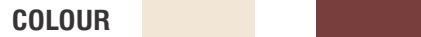

Please note: colors shown here are similar, not exact, to actual product colors.

MODULAR SYSTEMS- GREY



CABINET & DRAWERS DRAWER FRONT

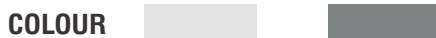

Please note: colors shown here are similar, not exact, to actual product colors.

MODULAR SYSTEMS-BLUE



CABINET & DRAWERS DRAWER FRONT

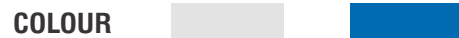

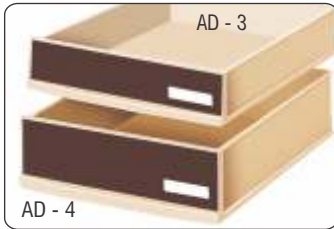
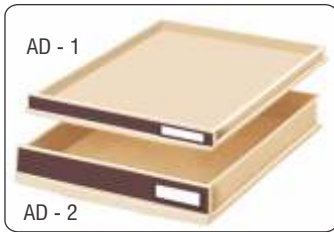

SPECIAL STOPPERS
Special stopper is provided to stop the drawers when opened fully. To remove drawer from the cabinet lift the drawer up & remove from cabinet.

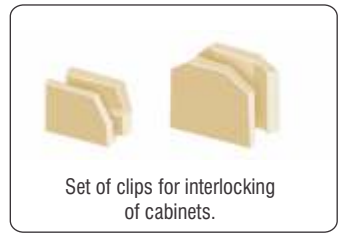

INTERNAL SIZE OF DRAWERS

- AD 1 360 mm 265 mm x 16 mm
- AD 2 360 mm x 265 mm x 39 mm
- AD 3 360 mm x 265 mm x 62 mm
- AD 4 360 mm x 265 mm x 87 mm
- AMS 12-Modular system with 12 AD 1 Drawers
- AMS 6 - Modular system with 6 AD 2 Drawers
- AMS 4 - Modular System with 4 AD 3 Drawers
- AMS 3 - Modular System with 3 AD 4 Drawers

MIXED DRAWER SYSTEM

Modular System can be fitted with different size of drawers in the same cabinet. For example, One AD-4 drawers, can be replaced by two AD -2 drawers, or one AD -3 drawer and one AD-1 drawer.

INDICATOR

Name plate can be changed by pushing out the paper from the indicator as shown.

BASE UNIT

Base unit can be used with castors to make a mobile unit. One or more base units can be used (Joined by set of four dowels provided) under the Modular system to raise the cabinet from the floor. Height of base unit is 35mm.

CENTRAL LOCKING SYSTEM

Is provided OPTIONALLY. Product numbers for cabinet with locks will be AMS 12L, AMS 6L, AMS 4L ect.

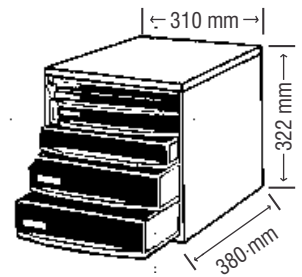

Mobile Unit Assembly



Combination of Containers

UTILITY CONTAINERS

For storing of small parts, Three sizes of containers are available to fit in AD3 / AD4 drawers.

Utility Containers available in 3 Sizes (in Beige & Grey Colours)

SIZES OF CONTAINERS :

- Art No. UC1 Size 82 x 82 x 55mm
12 Containers fit in one AD3/AD4 drawer
- Art No. UC2 Size 170 x 82 x 55mm
6 Containers fit in one AD3/AD4 drawer

- Art No. UC3 Size 255 x 82 x 55mm
4 Containers fit in one AD3/AD4 drawer
- Art No. UC2D Size 258 x 85 x 37mm with 2 partition
6 Containers fit In one AD2 Drawer

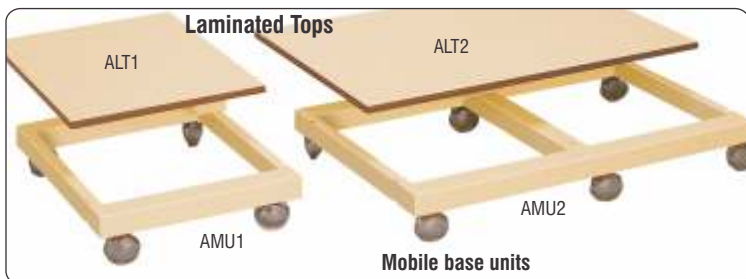

Laminated Tops

ALT1

ALT2

AMU1

AMU2

Mobile base units